

Water Purification System

aquapuri 5 series

The Most In-demand WPS in Your Lab



Алматы (7273)495-231
Ангарск (3955)60-70-56
Архангельск (8182)63-90-72
Астрахань (8512)99-46-04
Барнаул (3852)73-04-60
Белгород (4722)40-23-64
Благовещенск (4162)22-76-07
Брянск (4832)59-03-52
Владивосток (423)249-28-31
Владикавказ (8672)28-90-48
Владимир (4922)49-43-18
Волгоград (844)278-03-48
Вологда (8172)26-41-59
Воронеж (473)204-51-73
Екатеринбург (343)384-55-89

Иваново (4932)77-34-06
Ижевск (3412)26-03-58
Иркутск (395)279-98-46
Казань (843)206-01-48
Калининград (4012)72-03-81
Калуга (4842)92-23-67
Кемерово (3842)65-04-62
Киров (8332)68-02-04
Коломна (4966)23-41-49
Кострома (4942)77-07-48
Краснодар (861)203-40-90
Красноярск (391)204-63-61
Курск (4712)77-13-04
Курган (3522)50-90-47
Липецк (4742)52-20-81

Магнитогорск (3519)55-03-13
Москва (495)268-04-70
Мурманск (8152)59-64-93
Набережные Челны (8552)20-53-41
Нижний Новгород (831)429-08-12
Новокузнецк (3843)20-46-81
Ноябрьск (3496)41-32-12
Новосибирск (383)227-86-73
Омск (3812)21-46-40
Орел (4862)44-53-42
Оренбург (3532)37-68-04
Пенза (8412)22-31-16
Петрозаводск (8142)55-98-37
Псков (8112)59-10-37
Пермь (342)205-81-47

Ростов-на-Дону (863)308-18-15
Рязань (4912)46-61-64
Самара (846)206-03-16
Санкт-Петербург (812)309-46-40
Саратов (845)249-38-78
Севастополь (8692)22-31-93
Саранск (8342)22-96-24
Симферополь (3652)67-13-56
Смоленск (4812)29-41-54
Сочи (862)225-72-31
Ставрополь (8652)20-65-13
Сургут (3462)77-98-35
Сыктывкар (8212)25-95-17
Тамбов (4752)50-40-97
Тверь (4822)63-31-35

Тольятти (8482)63-91-07
Томск (3822)98-41-53
Тула (4872)33-79-87
Тюмень (3452)66-21-18
Ульяновск (8422)24-23-59
Улан-Удэ (3012)59-97-51
Уфа (347)229-48-12
Хабаровск (4212)92-98-04
Чебоксары (8352)28-53-07
Челябинск (351)202-03-61
Череповец (8202)49-02-64
Чита (3022)38-34-83
Якутск (4112)23-90-97
Ярославль (4852)69-52-93

Россия +7(495)268-04-70

Казахстан +7(7172)727-132

Киргизия +996(312)96-26-47

<https://youngin.nt-rt.ru/> || ynb@nt-rt.ru

aquapuri 5

s Water Purification System

In laboratories, there are multiple needs of pure/ultra-pure water depending on various usage, and it's important to provide proper purity of water with superior productivity for efficient utilization.

In this sense, a water purification system (WPS), is the most fundamental instrument that requires the best efficiency for your laboratory.

aquapuri 5 series satisfy all of your needs with a versatile product range while ensuring excellent water quality and user-friendly operation. The tank-less integrated models (541/551 series) produce Type I grade water from tap water by eliminating the possibility of tank contamination.



aquapuri at a Glance



Tank-less System

- Minimized contamination
- Space-saving

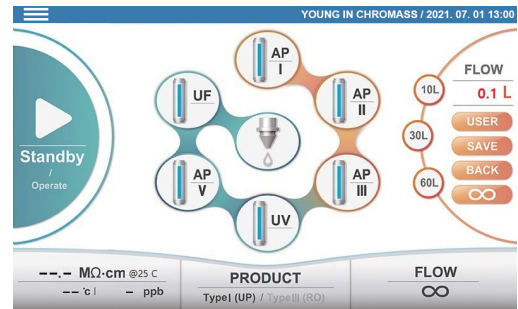

Intuitive Touch LCD

- Easy to control
- Intuitive status check (filter lifetime, water quality, etc.)



Simple Maintenance

- Tool-free replacement of filter
- Magnetic doors for easy access

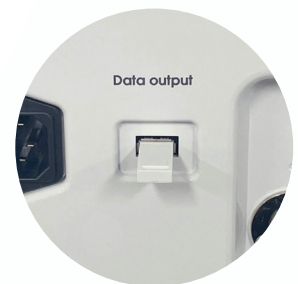

User Convenience

- Extendable dispenser up to 2 m (option)
- Data export via USB
- Single button dispenser

The Most In-demand WPS in Your Lab

No Tank, No Contamination

Unlike the traditional WPS, the integrated WPS (aquapuri 541/551 series) requires neither a water reservoir nor a Type II grade WPS to produce ultrapure water. It eliminates the possibility of secondary contamination and taking up much space to efficiently utilize the WPS.

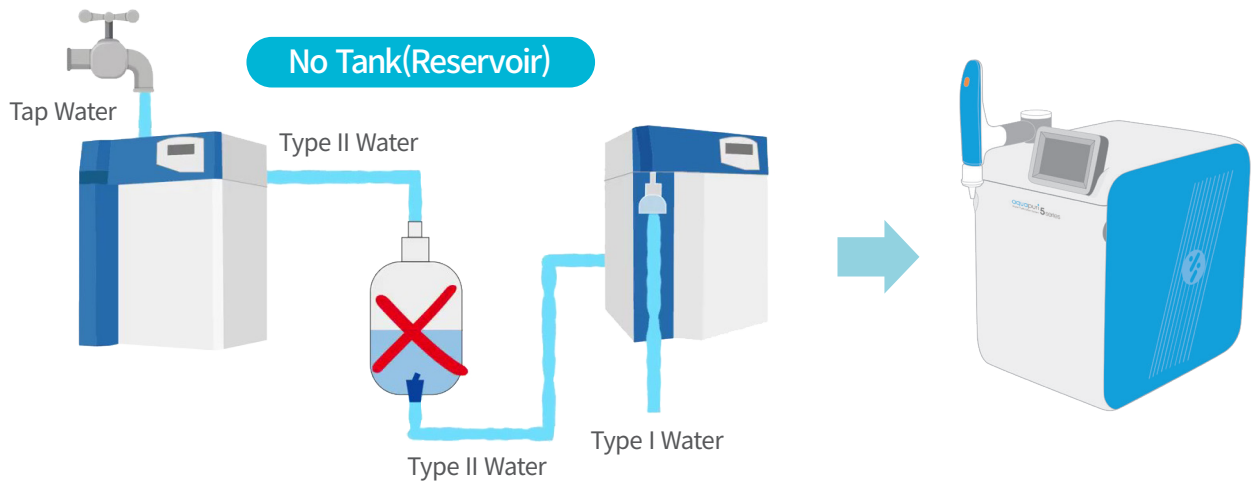

Intuitive Touch LCD

Intuitive touch-screen interface allows you to manage all parameters at a glance for easy operation at your fingertip. This enhances the efficiency and productivity to get pure/ultrapure water faster and easier.

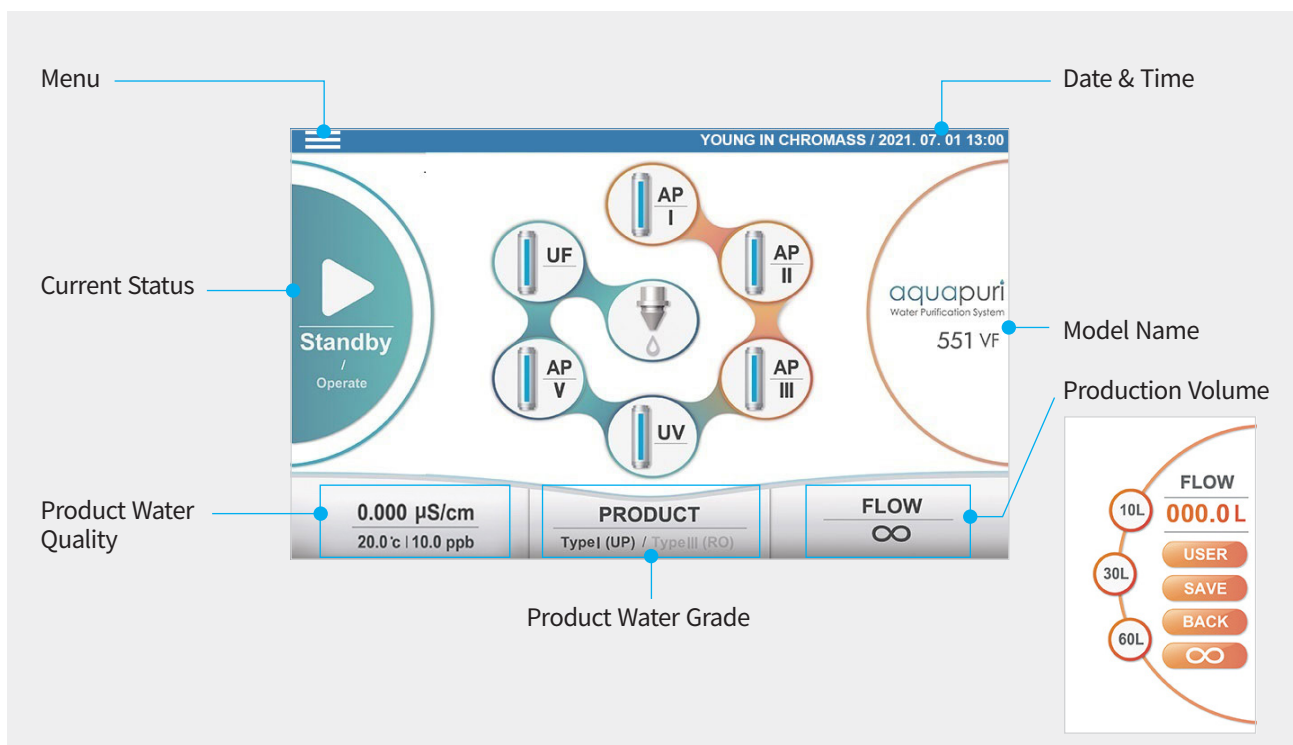

Real-Time Monitoring

aquapuri 5 WPS monitors resistivity (or conductivity) with temperature in real-time for you to keep tracking the water quality. In the flow diagram, the lifetime of each filter is indicated by color so you can be ready for the filter replacement.

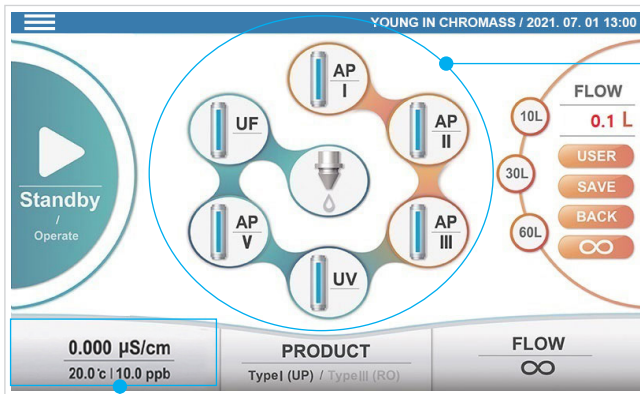

Filter lifetime monitoring

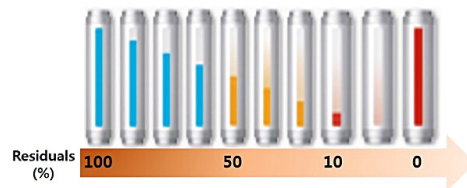

Real-time monitoring of resistivity (or conductivity) and TOC level with temperature

User Convenience

With a built-in single button dispenser, you can easily start/stop producing pure water by production volume. Optional extendable dispenser can be added to enhance the laboratory efficiency.

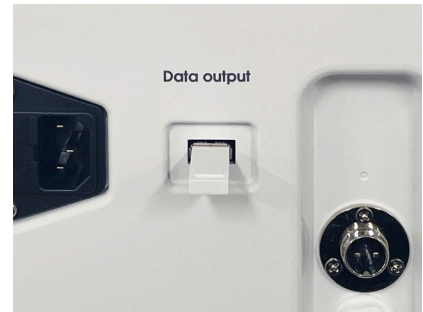

Tool-Free Maintenance

Magnetic-type doors applied to the front and both sides allow you easy access for maintenance. Insert-type filters make the filter replacement much easier with no tools.

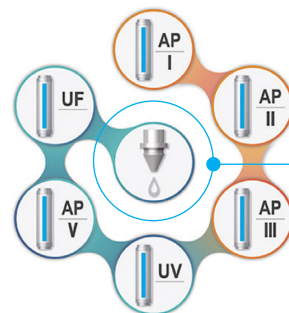

Filter replacement in batch

Selection Guide



Applications	<ul style="list-style-type: none"> • Washing/Rinsing • Autoclaves • Steam generators 	<ul style="list-style-type: none"> • Buffer/Media prep. • Electrophoresis • Feed water for Ultra-pure water 	<ul style="list-style-type: none"> • Reagents • General analysis (IC, AAS, HPLC, ICP-MS*) • Standard solvents 	<ul style="list-style-type: none"> • Ultra-trace inorganic/organic analysis • GC-MS/TOC analysis 	<ul style="list-style-type: none"> • Mammalian cell culture • DNA sequencing • Monoclonal antibody production 	<ul style="list-style-type: none"> • PCR • 2-Dimensional electrophoresis • Cell culture
Water Grade	Type III (R.O. water)	Type II (D.I. water)	Type I (Ultrapure water)			
Models	511 541 series	521 551 series	532 series 541 series 551 series	532UV 541UV 551UV	532UF 541UF 551UF	532VF 541VF 551VF

* For ICP-MS application, a dedicated filter is additionally required.

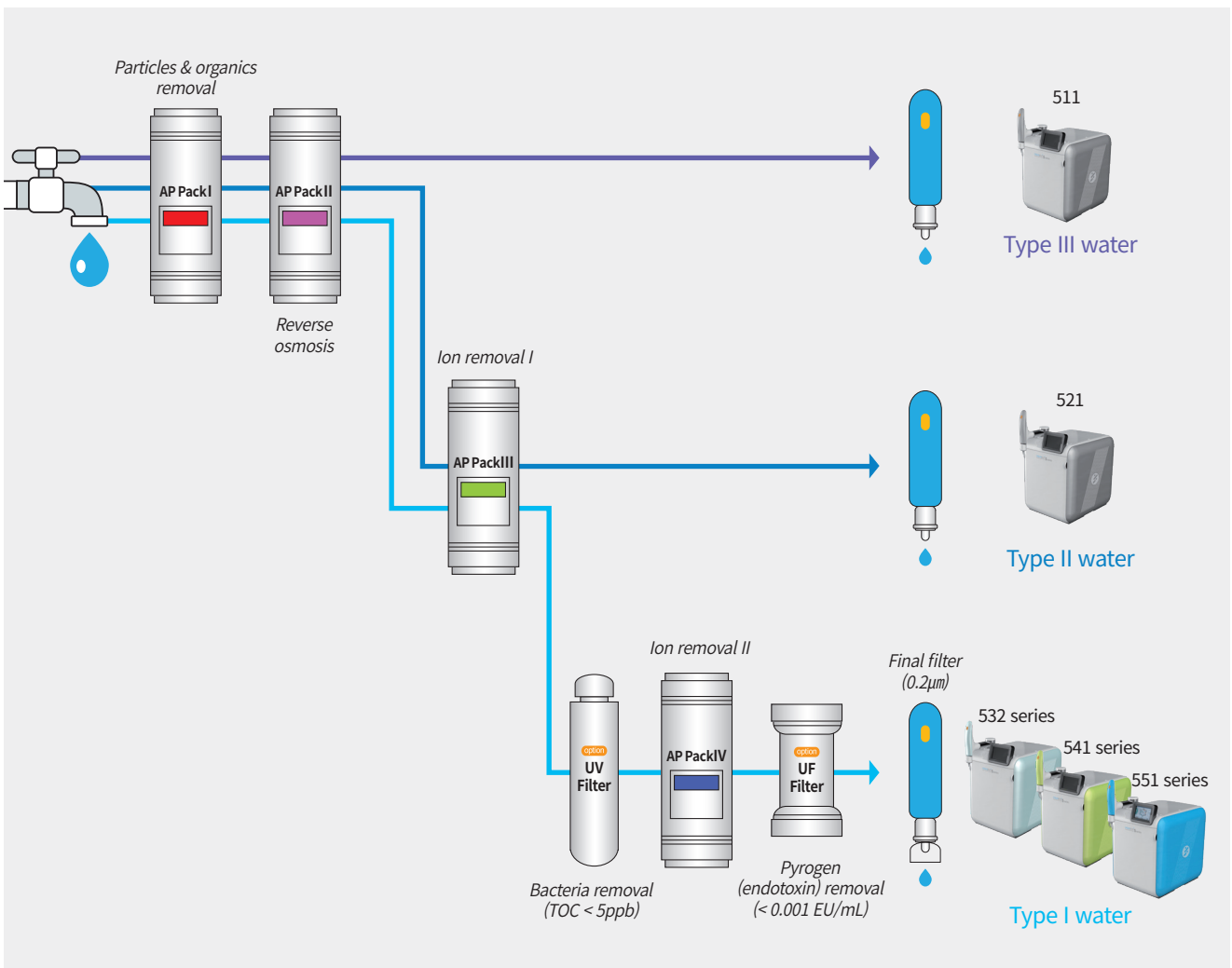
The Flow Diagram of aquapuri WPS



Specification

		511	521	532 Series*
Model				
Resistivity (@25°C)		≥ 10 MΩ·cm	≥ 10 MΩ·cm	≥ 18.2 MΩ·cm
Conductivity (@25°C)		≤ 0.1 μs/cm	≤ 0.1 μs/cm	≤ 0.055 μs/cm
Product Type		Type III	Type II	Type I
Product Volume		60 L/h	60 L/h	120 L/h
TOC	Standard, UF	-	-	3~10 ppb
	UV, VF	-	-	< 5 ppb
Endotoxin**		-	-	< 0.001 EU/mL

		541 series	551 series
Model			
Resistivity (@25°C)		≥ 18.2 MΩ·cm	≥ 18.2 MΩ·cm
Conductivity (@25°C)		≤ 0.055 μs/cm	≤ 0.055 μs/cm
Product Type		Type I, III	Type I, II
Product Volume		60 L/h	60 L/h
TOC	Standard, UF	3~10 ppb	3~10 ppb
	UV, VF	< 5 ppb	< 5 ppb
Endotoxin**		< 0.001 EU/mL	< 0.001 EU/mL

* Type II water is required as a feed water

** Endotoxin control only with UF, VF options



Алматы (7273)495-231
Ангарск (3955)60-70-56
Архангельск (8182)63-90-72
Астрахань (8512)99-46-04
Барнаул (3852)73-04-60
Белгород (4722)40-23-64
Благовещенск (4162)22-76-07
Брянск (4832)59-03-52
Владивосток (423)249-28-31
Владикавказ (8672)28-90-48
Владимир (4922)49-43-18
Волгоград (844)278-03-48
Вологда (8172)26-41-59
Воронеж (473)204-51-73
Екатеринбург (343)384-55-89

Иваново (4932)77-34-06
Ижевск (3412)26-03-58
Иркутск (395)279-98-46
Казань (843)206-01-48
Калининград (4012)72-03-81
Калуга (4842)92-23-67
Кемерово (3842)65-04-62
Киров (8332)68-02-04
Коломна (4966)23-41-49
Кострома (4942)77-07-48
Краснодар (861)203-40-90
Красноярск (391)204-63-61
Курск (4712)77-13-04
Курган (3522)50-90-47
Липецк (4742)52-20-81

Магнитогорск (3519)55-03-13
Москва (495)268-04-70
Мурманск (8152)59-64-93
Набережные Челны (8552)20-53-41
Нижний Новгород (831)429-08-12
Новокузнецк (3843)20-46-81
Ноябрьск (3496)41-32-12
Новосибирск (383)227-86-73
Омск (3812)21-46-40
Орел (4862)44-53-42
Оренбург (3532)37-68-04
Пенза (8412)22-31-16
Петрозаводск (8142)55-98-37
Псков (8112)59-10-37
Пермь (342)205-81-47

Ростов-на-Дону (863)308-18-15
Рязань (4912)46-61-64
Самара (846)206-03-16
Санкт-Петербург (812)309-46-40
Саратов (845)249-38-78
Севастополь (8692)22-31-93
Саранск (8342)22-96-24
Симферополь (3652)67-13-56
Смоленск (4812)29-41-54
Сочи (862)225-72-31
Ставрополь (8652)20-65-13
Сургут (3462)77-98-35
Сыктывкар (8212)25-95-17
Тамбов (4752)50-40-97
Тверь (4822)63-31-35

Тольятти (8482)63-91-07
Томск (3822)98-41-53
Тула (4872)33-79-87
Тюмень (3452)66-21-18
Ульяновск (8422)24-23-59
Улан-Удэ (3012)59-97-51
Уфа (347)229-48-12
Хабаровск (4212)92-98-04
Чебоксары (8352)28-53-07
Челябинск (351)202-03-61
Череповец (8202)49-02-64
Чита (3022)38-34-83
Якутск (4112)23-90-97
Ярославль (4852)69-52-93

Россия +7(495)268-04-70

Казахстан +7(7172)727-132

Киргизия +996(312)96-26-47

<https://youngin.nt-rt.ru/> || ynb@nt-rt.ru